

Pulegge per cinghie dentate
Timing belt pulleys
Zahnriemenscheiben
Poulies pour courroies dentées
Poleas para correas dentadas

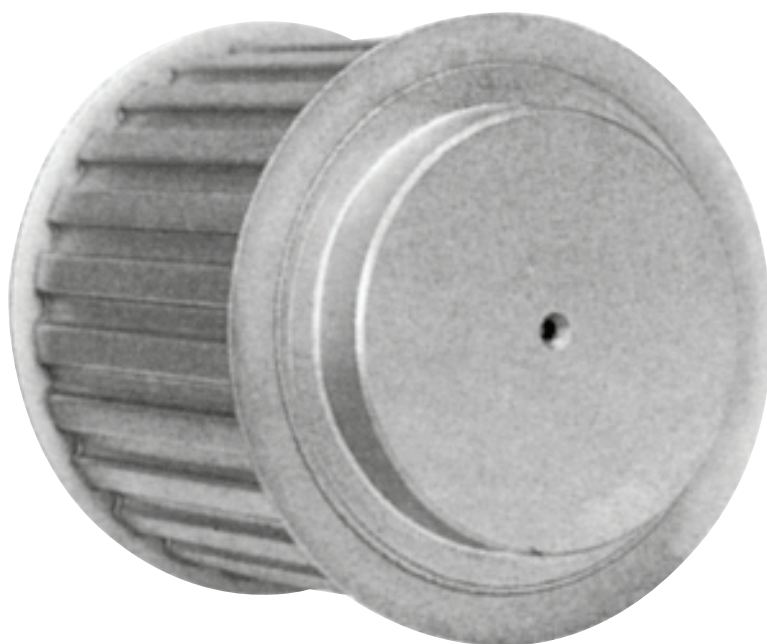

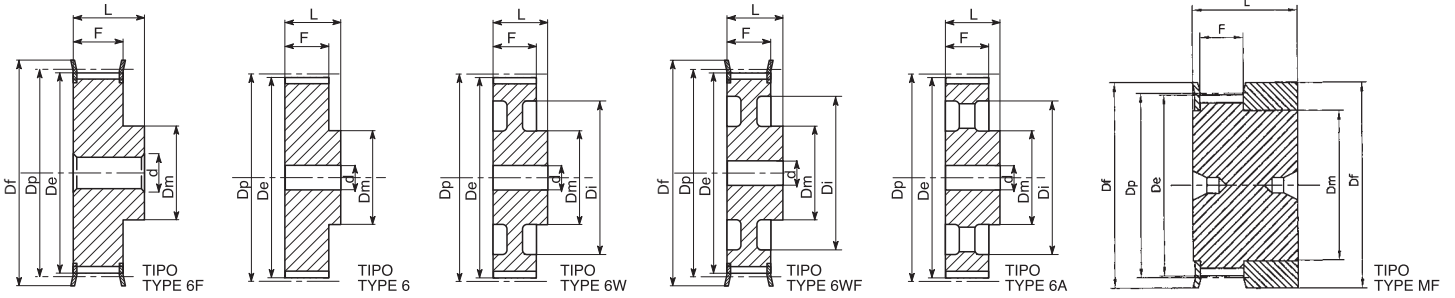

MXL 025 - 0,080" (2,032 mm)

Caratteristiche Features Merkmale Características	Codice Code symbol Fabriknummer Code symbole Numero de fabrica	Nostro codice Our code Unser kode Notre code Nuestro codigo	Tipo Type Typ Type Tipo	Tipo flangia Flanges type Bordscheiben Typ Type flasques Tipo tapetas	N. denti N. of teeth Zahnezahl N. bre de dents Cantidad de dientes	Dp	De	Df	Dm	Di	F	L	Foro stock Stock bore Vor bohrung Alesage en stock Agujero de stock	Peso Weight Gewicht Poids Peso Kg
Alluminio / Aluminium / Aluminium / Aluminium / Aluminium	16 MXL 025	MXL 2516	MF	F02	16	10,35	9,84	15,0	8,0	-	8,5	16	-	-
	18 MXL 025	MXL 2518	MF	F03	18	11,64	11,12	16,0	9,5	-	8,5	16	-	-
	20 MXL 025	MXL 2520	MF	F03	20	12,94	12,43	16,0	9,5	-	8,5	16	-	-
	22 MXL 025	MXL 2522	6F	F04	22	14,23	13,72	17,5	10,0	-	11,0	16	3	3
	24 MXL 025	MXL 2524	6F	F06	24	15,52	15,01	20,0	10,0	-	11,0	16	3	3
	28 MXL 025	MXL 2528	6F	F08	28	18,11	17,60	25,0	11,0	-	11,0	16	3	3
	30 MXL 025	MXL 2530	6F	F08	30	19,40	18,90	25,0	12,0	-	11,0	16	4	4
	32 MXL 025	MXL 2532	6F	F08	32	20,70	20,19	25,0	14,0	-	11,0	16	4	4
	36 MXL 025	MXL 2536	6F	F09	36	23,29	22,78	28,0	16,0	-	11,0	16	4	4
	40 MXL 025	MXL 2540	6F	F10	40	25,87	25,37	32,0	18,0	-	11,0	16	4	4
	42 MXL 025	MXL 2542	6F	F10	42	27,17	26,67	32,0	18,0	-	11,0	16	5	5
	44 MXL 025	MXL 2544	6F	F13	44	28,46	27,95	37,0	18,0	-	11,0	16	5	5
	Alluminio / Aluminium / Aluminium / Aluminium / Aluminium	48 MXL 025	MXL 2548	6	-	48	31,05	30,54	-	20,0	-	11,0	16	5
60 MXL 025		MXL 2560	6	-	60	38,81	38,30	-	24,0	-	11,0	16	5	5
72 MXL 025		MXL 2572	6	-	72	46,57	46,06	-	25,0	-	11,0	16	6	6

XL 037 - 1/5" (5,08 mm)

Caratteristiche Features Merkmale Características	Codice Code symbol Fabriknummer Code symbole Numero de fabrica	Nostro codice Our code Unser kode Notre code Nuestro codigo	Tipo Type Typ Type Tipo	Tipo flangia Flanges type Bordscheiben Typ Type flasques Tipo tapetas	N. denti N. of teeth Zahnezahl N. bre de dents Cantidad de dientes	Dp	De	Df	Dm	Di	F	L	Foro stock Stock bore Vor bohrung Alesage en stock Agujero de stock	Peso Weight Gewicht Poids Peso Kg		
Alluminio / Aluminium / Aluminium / Aluminium / Aluminium	10 XL 037	XA37010	XC37010	6F	F07	10	16,17	15,66	23	9,5	-	14,3	20	4	0,02	
	11 XL 037	XA37011	XC37011	6F	F07	11	17,79	17,28	23	9,5	-	14,3	20	4	0,02	
	12 XL 037	XA37012	XC37012	6F	F08	12	19,40	18,90	25	10	-	14,3	20	4	0,03	
	13 XL 037	XA37013	XC37013	6F	F08	13	21,02	20,51	25	10	-	14,3	20	4	0,04	
	14 XL 037	XA37014	XC37014	6F	F09	14	22,64	22,13	28	15	-	14,3	20	4	0,05	
	15 XL 037	XA37015	XC37015	6F	F09	15	24,26	23,75	28	15	-	14,3	20	6	0,05	
	16 XL 037	XA37016	XC37016	6F	F10	16	25,87	25,36	32	16	-	14,3	20	6	0,06	
	17 XL 037	XA37017	XC37017	6F	F10	17	27,49	26,98	32	20	-	14,3	20	6	0,07	
	18 XL 037	XA37018	XC37018	6F	F11	18	29,11	28,60	35	20	-	14,3	20	6	0,08	
	19 XL 037	XA37019	XC37019	6F	F11	19	30,72	30,22	35	20	-	14,3	22	6	0,09	
	20 XL 037	XA37020	XC37020	6F	F14	20	32,34	31,83	38	23,5	-	14,3	22	6	0,11	
	21 XL 037	XA37021	XC37021	6F	F14	21	33,96	33,45	38	23,5	-	14,3	22	6	0,12	
	22 XL 037	XA37022	XC37022	6F	F15	22	35,57	35,07	42	25	-	14,3	22	6	0,13	
	24 XL 037	XA37024	XC37024	6F	F17	24	38,81	38,30	44	30	-	14,3	22	6	0,15	
	26 XL 037	XA37026	XC37026	6F	F18	26	42,04	41,53	48	30	-	14,3	22	8	0,19	
	27 XL 037	XA37027	XC37027	6F	F18	27	43,66	43,15	48	34	-	14,3	22	8	0,20	
	28 XL 037	XA37028	XC37028	6F	F19	28	45,28	44,77	51	34	-	14,3	22	8	0,22	
	29 XL 037	XA37029	XC37029	6F	F19	29	46,89	46,39	51	34	-	14,3	22	8	0,22	
	30 XL 037	XA37030	XC37030	6F	F20	30	48,51	48,00	54	38	-	14,3	22	8	0,11	
	32 XL 037	XA37032	XC37032	6F	F21	32	51,74	51,24	57	38	-	14,3	25	8	0,12	
	Altern. / Altern. / Altern. / Altern. / Altern.	34 XL 037	XA37034	XC37034	6		34	54,98	54,47	-	45	-	14,3	25	8	0,12
35 XL 037		XA37035	XC37035	6		35	56,60	56,09	-	45	-	14,3	25	8	0,13	
36 XL 037		XA37036	XC37036	6		36	58,21	57,70	-	45	-	14,3	25	8	0,14	
38 XL 037		XA37038	XC37038	6		38	61,45	60,94	-	45	-	14,3	25	8	0,16	
39 XL 037		XA37039	XC37039	6		39	63,06	62,56	-	45	-	14,3	25	8	0,17	
40 XL 037		XA37040	XC37040	6		40	64,68	64,17	-	45	-	14,3	25	8	0,17	
41 XL 037		XA37041	XC37041	6		41	66,30	65,79	-	45	-	14,3	25	8	0,18	
42 XL 037		XA37042	XC37042	6		42	67,91	67,41	-	45	-	14,3	25	8	0,18	
43 XL 037		XA37043	XC37043	6		43	69,53	69,02	-	45	-	14,3	25	8	0,19	
44 XL 037		XA37044	XC37044	6		44	71,15	70,64	-	45	-	14,3	25	8	0,19	
Acciaio / Steel / Stahl / Acero		45 XL 037	XA37045	XC37045	6W		45	72,77	72,26	-	45	61	14,3	25	10	0,19
		46 XL 037	XA37046	XC37046	6W		46	74,38	73,87	-	45	61	14,3	25	10	0,19
		47 XL 037	XA37047	XC37047	6W		47	76,00	75,49	-	45	61	14,3	25	10	0,19
		48 XL 037	XA37048	XC37048	6W		48	77,62	77,11	-	45	61	14,3	25	10	0,19
	49 XL 037	XA37049	XC37049	6W		49	79,23	78,73	-	45	61	14,3	25	10	0,22	
	52 XL 037	XA37052	XC37052	6W		52	84,08	83,58	-	45	67	14,3	25	10	0,22	
	56 XL 037	XA37056	XC37056	6W		56	90,55	90,04	-	45	80	14,3	25	10	0,25	
	57 XL 037	XA37057	XC37057	6W		57	92,17	91,66	-	45	80	14,3	25	10	0,25	
	58 XL 037	XA37058	XC37058	6W		58	93,79	93,28	-	45	80	14,3	25	10	0,25	
	59 XL 037	XA37059	XC37059	6W		59	95,40	94,90	-	45	80	14,3	25	10	0,25	
	60 XL 037	XA37060	XC37060	6W		60	97,02	96,51	-	45	80	14,3	25	10	0,25	
	68 XL 037	XA37068	XC37068	6W		68	109,96	109,45	-	45	100	14,3	25	10	0,30	
	69 XL 037	XA37069	XC37069	6W		69	111,57	111,07	-	45	100	14,3	25	10	0,30	
	70 XL 037	XA37070	XC37070	6W		70	113,19	112,68	-	45	100	14,3	25	10	0,30	
71 XL 037	XA37071	XC37071	6W		71	114,81	114,30	-	45	100	14,3	25	10	0,30		
72 XL 037	XA37072	XC37072	6W		72	116,42	115,92	-	45	100	14,3	25	10	0,30		

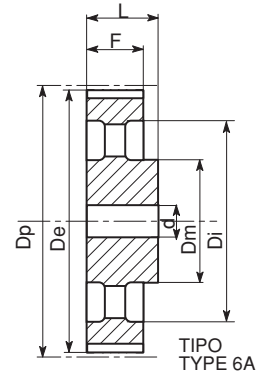
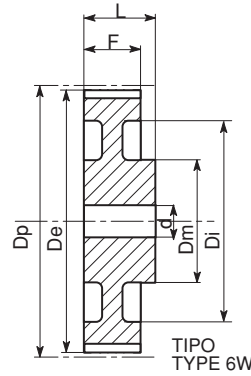
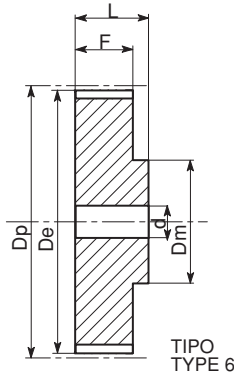
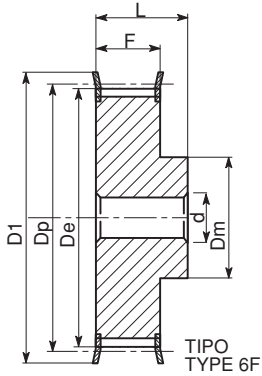

XXH 200 - 1" 1/4 (31,750 mm)

Caratteristiche Features Merkmale Características	Codice Code symbol Fabriknummer Code symbole Numero de fabrica	Nostro codice Our code Unser kode Notre code Nuestro codigo	Tipo Type Typ Type Tipo	Tipo flangia Flanges type Bordscheiben Typ Type flasques Tipo tapetas	N. denti N. of teeth Zahnezahl N. bre de dents Cantidad de dientes	Dp	De	Df	Dm	Di	F	L	Foro stock Stock bore Vor bohrung Alesage en stock Agujero de stock	Peso Weight / Gewicht Poids / Peso Kg	
Acciaio / Steel / Stahl Acier / Acero	con flangia / with flanges mit Flanges / avec flasques con tapetas	18XXH200	XXH2018	6F	F58	18	181,91	178,87	198	140	—	64,2	100	28	14,2
		19XXH200	XXH2019	6F	F60	19	192,02	188,97	205	140	—	64,2	100	28	15,8
		20XXH200	XXH2020	6F	F61	20	202,13	199,08	212	150	—	64,2	100	28	17,3
		21XXH200	XXH2021	6F	F62	21	212,23	209,19	226	150	—	64,2	100	28	18,5
		22XXH200	XXH2022	6F	F64	22	222,34	219,29	240	150	—	64,2	100	28	20,0
		24XXH200	XXH2024	6		24	242,55	239,50	—	150	—	64,2	100	28	23,6
Ghisa / Cast iron / Grauguss Fonte / Hierro fundido	senza flangia / without flanges ohne Flanschen / sans flasques sin tapetas	25XXH200	XXH2025	6W		25	252,66	249,61	—	150	196	64,2	100	28	18,0
		26XXH200	XXH2026	6W		26	262,76	259,79	—	150	207	64,2	100	28	20,0
		27XXH200	XXH2027	6W		27	272,87	269,82	—	150	216	64,2	100	28	24,0
		30XXH200	XXH2030	6W		30	303,19	300,14	—	150	247	64,2	100	28	26,0
		34XXH200	XXH2034	6W		34	343,62	340,57	—	150	287	64,2	100	28	31,8
		40XXH200	XXH2040	6W		40	404,25	401,21	—	150	348	64,2	100	28	43,0
		48XXH200	XXH2048	6W		48	485,10	482,06	—	175	429	64,2	100	32	60,4
		60XXH200	XXH2060	6A		60	606,38	603,33	—	175	547	64,2	120	32	100,0
		72XXH200	XXH2072	6A		72	727,66	724,61	—	175	668	64,2	120	38	130,0
		90XXH200	XXH2090	6A		90	909,57	906,52	—	175	850	64,2	120	38	156,0

XXH 300 - 1" 1/4 (31,750 mm)

Caratteristiche Features Merkmale Características	Codice Code symbol Fabriknummer Code symbole Numero de fabrica	Nostro codice Our code Unser kode Notre code Nuestro codigo	Tipo Type Typ Type Tipo	Tipo flangia Flanges type Bordscheiben Typ Type flasques Tipo tapetas	N. denti N. of teeth Zahnezahl N. bre de dents Cantidad de dientes	Dp	De	Df	Dm	Di	F	L	Foro stock Stock bore Vor bohrung Alesage en stock Agujero de stock	Peso Weight / Gewicht Poids / Peso Kg	
Acciaio / Steel / Stahl Acier / Acero	con flangia / with flanges mit Flanges / avec flasques con tapetas	18XXH300	XXH30018	6F	F58	18	181,91	178,87	198	140	—	91,4	110	28	16,0
		19XXH300	XXH30019	6F	F60	19	192,02	188,97	205	140	—	91,4	110	28	18,4
		20XXH300	XXH30020	6F	F61	20	202,13	199,08	212	150	—	91,4	110	28	20,4
		21XXH300	XXH30021	6F	F62	21	212,23	209,19	226	150	—	91,4	110	28	22,0
		22XXH300	XXH30022	6F	F64	22	222,34	219,29	240	150	—	91,4	110	28	25,0
		24XXH300	XXH30024	6		24	242,55	239,50	—	150	—	91,4	110	28	29,2
Ghisa / Cast iron / Grauguss Fonte / Hierro fundido	senza flangia / without flanges ohne Flanschen / sans flasques sin tapetas	25XXH300	XXH30025	6W		25	252,66	249,61	—	150	196	91,4	110	28	24,6
		26XXH300	XXH30026	6W		26	262,76	259,79	—	150	207	91,4	110	28	27,0
		27XXH300	XXH30027	6W		27	272,87	269,82	—	150	216	91,4	110	28	29,0
		30XXH300	XXH30030	6W		30	303,19	300,14	—	150	247	91,4	110	28	31,0
		34XXH300	XXH30034	6W		34	343,62	340,57	—	150	287	91,4	110	28	39,0
		40XXH300	XXH30040	6W		40	404,25	401,21	—	150	348	91,4	110	28	45,0
		48XXH300	XXH30048	6W		48	485,10	482,06	—	175	429	91,4	110	32	60,0
		60XXH300	XXH30060	6A		60	606,38	603,33	—	175	547	91,4	120	32	100,0
		72XXH300	XXH30072	6A		72	727,66	724,61	—	175	668	91,4	120	38	135,0
		90XXH300	XXH30090	6A		90	909,57	906,52	—	175	850	91,4	120	38	160,0

Pulegge per cinghie dentate / Timing belt pulleys Zahnriemenscheiben / Poulies pour courroies dentées / Poleas para correas dentadas

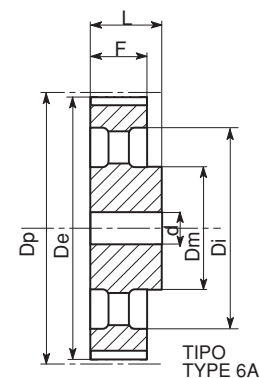
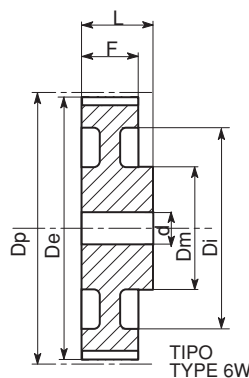
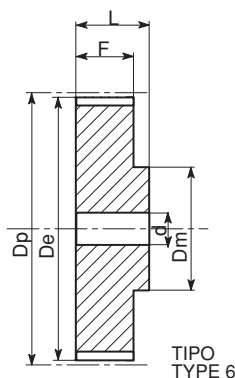
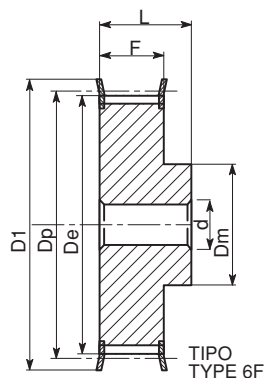

XXH 400 - 1" 1/4 (31,750 mm)

Caratteristiche Features Merkmal Características	Codice Code symbol Fabriknummer Code symbole Numero de fabrica	Nostro codice Our code Unser kode Notre code Nuestro codigo	Tipo Type Typ Type Tipo	Tipo flangia Flanges type Bordscheiben Typ Type flasques Tipo tapetas	N. denti N. of teeth Zahnezahl N. bre de dents Cantidad de dientes	Dp	De	Df	Dm	Di	F	L	Foro stock Stock bore Vor bohrung Alesage en stock Agujero de stock	Peso Weight / Gewicht Poids / Peso Kg	
Acciaio / Steel / Stahl Acier / Acero	con flangia / with flanges mit Flanges / avec flasques con tapetas	18XXH400	XXH4018	6F	F58	18	181,91	178,87	198	140	—	120,7	140	32	20,8
		19XXH400	XXH4019	6F	F60	19	192,02	188,97	205	140	—	120,7	140	32	24,0
		20XXH400	XXH4020	6F	F61	20	202,13	199,08	212	150	—	120,7	140	32	26,0
		21XXH400	XXH4021	6F	F62	21	212,23	209,19	226	150	—	120,7	140	32	28,5
		22XXH400	XXH4022	6F	F64	22	222,34	219,29	240	150	—	120,7	140	32	31,6
		24XXH400	XXH4024	6		24	242,55	239,50	—	150	—	120,7	140	32	35,0
Ghisa / Cast iron / Grauguss Fonte / Hierro fundido	senza flangia / without flanges ohne Flanschen / sans flasques sin tapetas	25XXH400	XXH4025	6W		25	252,66	249,61	—	150	196	120,7	140	32	28,0
		26XXH400	XXH4026	6W		26	262,76	259,79	—	150	207	120,7	140	32	32,4
		27XXH400	XXH4027	6W		27	272,87	269,82	—	150	216	120,7	140	32	34,0
		30XXH400	XXH4030	6W		30	303,19	300,14	—	185	247	120,7	140	32	36,0
		34XXH400	XXH4034	6W		34	343,62	340,57	—	185	287	120,7	140	32	47,6
		40XXH400	XXH4040	6W		40	404,25	401,21	—	185	348	120,7	140	32	65,0
		48XXH400	XXH4048	6W		48	485,10	482,06	—	185	429	120,7	140	38	80,5
		60XXH400	XXH4060	6A		60	606,38	603,33	—	185	547	120,7	140	38	108,0
		72XXH400	XXH4072	6A		72	727,66	724,61	—	220	668	120,7	140	38	140,0
90XXH400	XXH4090	6A		90	909,57	906,52	—	220	850	120,7	140	38	170,0		

XXH 500 - 1" 1/4 (31,750 mm)

Caratteristiche Features Merkmal Características	Codice Code symbol Fabriknummer Code symbole Numero de fabrica	Nostro codice Our code Unser kode Notre code Nuestro codigo	Tipo Type Typ Type Tipo	Tipo flangia Flanges type Bordscheiben Typ Type flasques Tipo tapetas	N. denti N. of teeth Zahnezahl N. bre de dents Cantidad de dientes	Dp	De	Df	Dm	Di	F	L	Foro stock Stock bore Vor bohrung Alesage en stock Agujero de stock	Peso Weight / Gewicht Poids / Peso Kg	
Acciaio / Steel / Stahl Acier / Acero	con flangia / with flanges mit Flanges / avec flasques con tapetas	18XXH500	XXH5018	6F	F58	18	181,91	178,87	198	140	—	145,3	168	32	24,0
		19XXH500	XXH5019	6F	F60	19	192,02	188,97	205	140	—	145,3	168	32	28,0
		20XXH500	XXH5020	6F	F61	20	202,13	199,08	212	150	—	145,3	168	32	31,4
		21XXH500	XXH5021	6F	F62	21	212,23	209,19	226	150	—	145,3	168	32	34,0
		22XXH500	XXH5022	6F	F64	22	222,34	219,29	240	150	—	145,3	168	32	38,3
		24XXH500	XXH5024	6		24	242,55	239,50	—	150	—	145,3	168	32	45,0
Ghisa / Cast iron / Grauguss Fonte / Hierro fundido	senza flangia / without flanges ohne Flanschen / sans flasques sin tapetas	25XXH500	XXH5025	6W		25	252,66	249,61	—	150	196	145,3	168	32	36,0
		26XXH500	XXH5026	6W		26	262,76	259,79	—	150	207	145,3	168	32	37,5
		27XXH500	XXH5027	6W		27	272,87	269,82	—	150	216	145,3	168	32	42,0
		30XXH500	XXH5030	6W		30	303,19	300,14	—	215	247	145,3	168	32	46,8
		34XXH500	XXH5034	6W		34	343,62	340,57	—	215	287	145,3	168	32	57,0
		40XXH500	XXH5040	6W		40	404,25	401,21	—	215	348	145,3	168	32	68,0
		48XXH500	XXH5048	6W		48	485,10	482,06	—	215	429	145,3	168	38	88,8
		60XXH500	XXH5060	6A		60	606,38	603,33	—	240	547	145,3	120	38	99,8
		72XXH500	XXH5072	6A		72	727,66	724,61	—	240	668	145,3	120	38	172,0
90XXH500	XXH5090	6A		90	909,57	906,52	—	240	850	145,3	120	38	242,5		

Le barre dentate XL e L sono costruite in acciaio UNI C 40 e in alluminio UNI 3571 TA 16, adatte alla anodizzazione. Le barre MXL sono costruite solo in alluminio.

The timing bars XL and L are made of steel UNI C 40 and of aluminium UNI 3571 TA 16, suitable for anodic treatment, whereas the bars MXL are made of aluminium only.

Die stangen XL und L sind aus stahl UNI C 40 und aluminium UNI 3571 TA 16 geeignet fuer anodischen oxydation. Die stangen MXL werden nur aus aluminium gefertigt.

Les barreaux dents XL et L sont fabriqués en acier UNI C 40 et en aluminium UNI 3571 TA 16, apte au traitement anodi = que, tandis que les barreaux MXL ne sont fabriqués qu'en aluminium.

Las barras dentadas XL y L se construyen en acero UNI C 40 y en aluminio UNI 3571 TA 16 para la oxidacion anodica, mientras que las barras MXL solo se fabrican en aluminio.

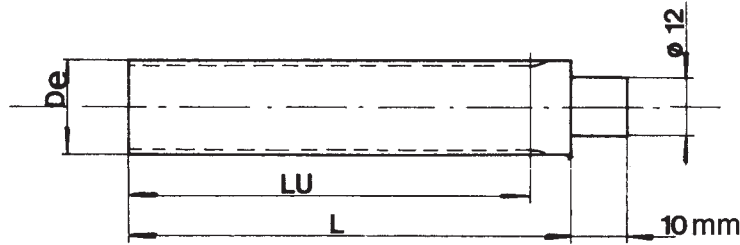



MXL - 0.080" (mm 2,032)

XL - 1/5" (mm 5,08)

L - 3/8" (mm 9,525)

Codice Code symbol Fabriknummer Code symbole Numero de fabrica	Nostro codice Our code Unser kode Notre code Nuestro codigo	N. denti N. of teeth Zahnezahl N. bre de dents Cantidad de dientes	De	LU	L	Codice Code symbol Fabriknummer Code symbole Numero de fabrica	Nostro codice Our code Unser kode Notre code Nuestro codigo		N. denti N. of teeth Zahnezahl N. bre de dents Cantidad de dientes	De	LU	L	Codice Code symbol Fabriknummer Code symbole Numero de fabrica	Nostro codice Our code Unser kode Notre code Nuestro codigo		N. denti N. of teeth Zahnezahl N. bre de dents Cantidad de dientes	De	LU	L
							AL	C40						AL	C40				
MXL 11	BMXL 011	11	6,60	50	75	XL 10	BXLA 010	BXLC 010	10	15,66	125	140	L 10	BOLA 010	BOLC 010	10	29,56	140	140
MXL 12	BMXL 012	12	7,26	50	75	XL 11	BXLA 011	BXLC 011	11	17,28	125	140	L 11	BOLA 011	BOLC 011	11	32,59	140	140
MXL 13	BMXL 013	13	7,90	50	75	XL 12	BXLA 012	BXLC 012	12	18,90	125	140	L 12	BOLA 012	BOLC 012	12	35,62	160	160
MXL 14	BMXL 014	14	8,56	50	75	XL 13	BXLA 013	BXLC 013	13	20,51	125	140	L 13	BOLA 013	BOLC 013	13	38,65	160	160
MXL 15	BMXL 015	15	9,19	50	75	XL 14	BXLA 014	BXLC 014	14	22,13	132	140	L 14	BOLA 014	BOLC 014	14	41,68	160	160
MXL 16	BMXL 016	16	9,83	50	75	XL 15	BXLA 015	BXLC 015	15	23,75	132	140	L 15	BOLA 015	BOLC 015	15	44,72	160	160
MXL 17	BMXL 017	17	10,49	50	75	XL 16	BXLA 016	BXLC 016	16	25,36	140	140	L 16	BOLA 016	BOLC 016	16	47,75	160	160
MXL 18	BMXL 018	18	11,12	50	75	XL 17	BXLA 017	BXLC 017	17	26,98	140	140	L 17	BOLA 017	BOLC 017	17	50,78	160	160
MXL 19	BMXL 019	19	11,78	90	120	XL 18	BXLA 018	BXLC 018	18	28,60	140	140	L 18	BOLA 018	BOLC 018	18	53,81	160	160
MXL 20	BMXL 020	20	12,42	90	120	XL 19	BXLA 019	BXLC 019	19	30,22	140	140	L 19	BOLA 019	BOLC 019	19	56,84	160	160
MXL 21	BMXL 021	21	13,08	90	120	XL 20	BXLA 020	BXLC 020	20	31,83	140	140	L 20	BOLA 020	BOLC 020	20	59,88	160	160
MXL 22	BMXL 022	22	13,72	125	140	XL 21	BXLA 021	BXLC 021	21	33,45	160	160	L 21	BOLA 021	BOLC 021	21	62,91	160	160
MXL 23	BMXL 023	23	14,38	125	140	XL 22	BXLA 022	BXLC 022	22	35,07	160	160	L 22	BOLA 022	BOLC 022	22	65,94	160	160
MXL 24	BMXL 024	24	15,01	125	140	XL 23	BXLA 023	BXLC 023	23	36,60	160	160	L 23	BOLA 023	BOLC 023	23	68,97	160	160
MXL 25	BMXL 025	25	15,67	125	140	XL 24	BXLA 024	BXLC 024	24	38,30	160	160	L 24	BOLA 024	BOLC 024	24	72,00	160	160
MXL 26	BMXL 026	26	16,31	125	140	XL 25	BXLA 025	BXLC 025	25	39,93	160	160	L 27	BOLA 027	BOLC 027	27	81,10	160	160
MXL 27	BMXL 027	27	16,94	125	140	XL 26	BXLA 026	BXLC 026	26	41,53	160	160	L 30	BOLA 030	BOLC 030	30	90,20	160	160
MXL 28	BMXL 028	28	16,70	125	140	XL 27	BXLA 027	BXLC 027	27	43,15	160	160							
MXL 29	BMXL 029	29	18,24	125	140	XL 28	BXLA 028	BXLC 028	28	44,77	160	160							
MXL 30	BMXL 030	30	18,90	125	140	XL 29	BXLA 029	BXLC 029	29	46,39	160	160							
MXL 32	BMXL 032	32	20,19	125	140	XL 30	BXLA 030	BXLC 030	30	48,00	160	160							
MXL 34	BMXL 034	34	21,49	125	140	XL 32	BXLA 032	BXLC 032	32	51,24	160	160							
MXL 35	BMXL 035	35	22,12	132	140	XL 34	BXLA 034	BXLC 034	34	54,47	160	160							
MXL 36	BMXL 036	36	22,78	132	140	XL 35	BXLA 035	BXLC 035	35	56,09	160	160							
MXL 38	BMXL 038	38	24,08	132	140	XL 36	BXLA 036	BXLC 036	36	57,70	160	160							
MXL 40	BMXL 040	40	25,37	132	140	XL 38	BXLA 038	BXLC 038	38	60,94	160	160							
MXL 42	BMXL 042	42	26,67	140	140	XL 40	BXLA 040	BXLC 040	40	64,17	160	160							
MXL 44	BMXL 044	44	27,94	140	140	XL 42	BXLA 042	BXLC 042	42	67,41	160	160							
MXL 45	BMXL 045	45	28,60	140	140	XL 44	BXLA 044	BXLC 044	44	70,64	160	160							
MXL 48	BMXL 048	48	30,53	140	140	XL 45	BXLA 045	BXLC 045	45	72,26	160	160							
MXL 50	BMXL 050	50	32,33	140	140	XL 48	BXLA 048	BXLC 048	48	77,11	160	160							
MXL 60	BMXL 060	60	38,30	160	160	XL 50	BXLA 050	BXLC 050	50	80,33	160	160							
MXL 64	BMXL 064	64	40,89	160	160	XL 60	BXLA 060	BXLC 060	60	96,51	160	160							
MXL 65	BMXL 065	65	41,53	160	160	XL 64	BXLA 064	BXLC 064	64	102,95	160	160							
MXL 70	BMXL 070	70	44,78	160	160	XL 65	BXLA 065	BXLC 065	65	104,56	160	160							
MXL 72	BMXL 072	72	46,05	160	160	XL 70	BXLA 070	BXLC 070	70	112,68	160	160							
MXL 75	BMXL 075	75	48,01	160	160	XL 72	BXLA 072	BXLA 072	72	115,92	160	160							
MXL 90	BMXL 090	90	57,71	160	160														
MXL 110	BMXL 110	110	70,64	160	160														

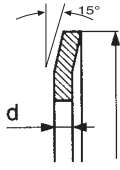

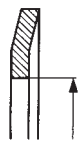
N. denti N. of teeth Zahnezahl N. bre de dents Cantidad de dientes	Flangia / Flanges / Bordscheiben / Flasques / Tapetas						Tipo flangia Flanges type Bordscheiben Typ Type flasques Tipo tapetas			
	d = 0,5 mm	d = 1 mm	d = 1,5 mm	d = 1,5 mm	d = 2,5 mm	d = 2,5 mm				
	MXL	XL	L	H	XH	XXH				
8	-	-	-	-	-	-				
9	-	-	-	-	-	-				
10	-	F 07	F 13	-	-	-	F 01	13,0	10,0	6,0
11	-	F 07	F 13	-	-	-	F 02	15,0	12,0	8,0
12	-	F 08	F 16	-	-	-	F 03	16,0	13,0	9,5
13	-	F 08	F 17	-	-	-	F 04	17,5	14,5	11,6
14	-	F 09	F 18	F 24	-	-	F 05	18,0	15,0	11,5
15	-	F 09	F 19	F 25	-	-	F 06	20,0	16,5	12,2
16	F 02	F 10	F 20	F 26	-	-	F 07	23,0	18,0	12,5
17	-	F 10	F 21	F 27	-	-	F 08	25,0	21,5	15,0
18	F 03	F 11	F 22	F 28	F 44	F 58	F 09	28,0	24,0	17,8
19	-	F 11	F 24	F 29	F 46	F 60	F 10	32,0	27,5	23,0
20	F 03	F 14	F 25	F 30	F 49	F 61	F 11	35,0	30,5	23,0
21	-	F 14	F 26	F 31	F 51	F 62	F 12	36,0	31,0	25,0
22	F 04	F 15	F 27	F 32	F 52	F 64	F 13	37,0	33,0	25,0
23	-	-	F 28	F 33	-	-	F 14	38,0	34,0	26,5
24	F 06	F 17	F 28	F 34	F 81	-	F 15	42,0	38,0	30,5
25	-	-	F 29	F 35	F 56	-	F 16	43,0	39,0	31,0
26	-	F 18	F 30	F 36	F 59	-	F 17	44,0	40,5	32,5
27	-	F 18	F 30	F 37	F 59	-	F 18	48,0	43,5	37,0
28	F 08	F 19	F 31	F 38	F 61	-	F 19	51,0	47,0	40,0
29	-	F 19	F 32	F 39	-	-	F 20	54,0	50,5	43,0
30	F 08	F 24	F 33	F 40	F 62	-	F 21	57,0	52,0	46,0
31	-	-	-	-	-	-	F 22	60,0	57,0	47,0
32	F 08	F 21	F 34	F 42	F 64	-	F 23	61,0	56,5	49,0
33	-	-	F 35	F 44	-	-	F 24	64,0	57,0	47,0
34	-	-	F 34	F 48	F 66	-	F 25	66,0	63,0	52,0
35	-	-	F 36	F 48	-	-	F 26	70,0	66,5	53,0
36	F 09	-	F 37	F 48	-	-	F 27	75,0	68,5	60,0
37	-	-	-	-	-	-	F 28	79,0	72,5	60,0
38	-	-	-	F 50	F 69	-	F 29	83,0	78,0	68,0
39	-	-	-	-	-	-	F 30	87,0	82,5	72,0
40	F 10	-	F 40	F 52	F 70	-	F 31	91,0	85,5	76,0
41	-	-	F 41	-	-	-	F 32	93,0	89,0	80,0
42	F 10	-	F 42	F 53	-	-	F 33	97,0	93,8	83,0
43	-	-	-	-	-	-	F 34	102,0	97,0	82,5
44	F 13	-	F 45	F 55	-	-	F 35	106,0	101,0	90,0
45	-	-	F 45	F 57	-	-	F 36	112,0	105,5	91,0
46	-	-	-	-	-	-	F 37	115,0	109,0	94,0
47	-	-	F 48	-	-	-	F 38	120,0	112,5	99,5
48	-	-	F 48	F 59	-	-	F 39	123,0	117,5	107,0
49	-	-	-	-	-	-	F 40	128,0	124,0	107,0
50	-	-	-	-	-	-	F 41	131,0	125,5	115,0
51	-	-	-	-	-	-	F 42	135,0	128,5	115,0
52	-	-	-	-	-	-	F 43	138,0	132,0	121,0
53	-	-	-	-	-	-	F 44	140,0	125,0	107,0
54	-	-	-	-	-	-	F 45	142,0	137,0	120,0
55	-	-	-	-	-	-	F 46	146,0	133,0	107,0
56	-	-	-	-	-	-	F 47	148,0	143,0	132,0
57	-	-	-	-	-	-	F 48	150,0	145,0	130,0
58	-	-	-	-	-	-	F 49	154,0	142,0	122,0
59	-	-	-	-	-	-	F 50	158,0	153,0	138,5
60	-	-	-	-	-	-	F 51	160,0	148,0	120,0
61	-	-	-	-	-	-	F 52	168,0	161,0	148,0
63	-	-	-	-	-	-	F 53	175,0	170,0	157,0
64	-	-	-	-	-	-	F 54	180,0	174,0	154,0
65	-	-	-	-	-	-	F 55	184,0	177,0	162,0
66	-	-	-	-	-	-	F 56	188,0	176,0	150,0
67	-	-	-	-	-	-	F 57	192,0	187,0	173,0
68	-	-	-	-	-	-	F 58	198,0	180,0	150,0
69	-	-	-	-	-	-	F 59	200,0	193,0	180,0
70	-	-	-	-	-	-	F 60	205,0	189,0	160,0
71	-	-	-	-	-	-	F 61	212,0	200,0	162,0
72	-	-	-	-	-	-	F 62	226,0	214,0	190,0
73	-	-	-	-	-	-	F 63	230,0	222,0	200,0
74	-	-	-	-	-	-	F 64	240,0	224,0	192,0
75	-	-	-	-	-	-	F 65	250,0	228,0	200,0
76	-	-	-	-	-	-	F 66	256,0	240,0	220,0
77	-	-	-	-	-	-	F 67	265,0	240,0	213,0
78	-	-	-	-	-	-	F 68	275,0	253,0	225,0
79	-	-	-	-	-	-	F 69	286,0	277,0	242,0
80	-	-	-	-	-	-	F 70	296,0	287,0	260,0
81	-	-	-	-	-	-	F 71	300,0	280,0	252,0
82	-	-	-	-	-	-	F 72	325,0	305,0	278,0
83	-	-	-	-	-	-	F 73	350,0	330,0	302,0
84	-	-	-	-	-	-	F 74	375,0	355,0	328,0
85	-	-	-	-	-	-	F 75	405,0	380,0	354,0
86	-	-	-	-	-	-	F 76	430,0	406,0	380,0
87	-	-	-	-	-	-	F 77	455,0	432,0	405,0
88	-	-	-	-	-	-	F 78	480,0	457,0	430,0
89	-	-	-	-	-	-	F 79	530,0	508,0	481,0
90	-	-	-	-	-	-	F 80	595,0	572,0	544,0
							F 81	184,0	168,0	135,0

Pulegge dentate per bussola conica
Timing belt pulleys for taper bushes
Zahnriemenscheiben für Spannbüchsen
Poulies dentées à moyeu amovible
Poleas dentadas para
casquillos cónicos (taper)

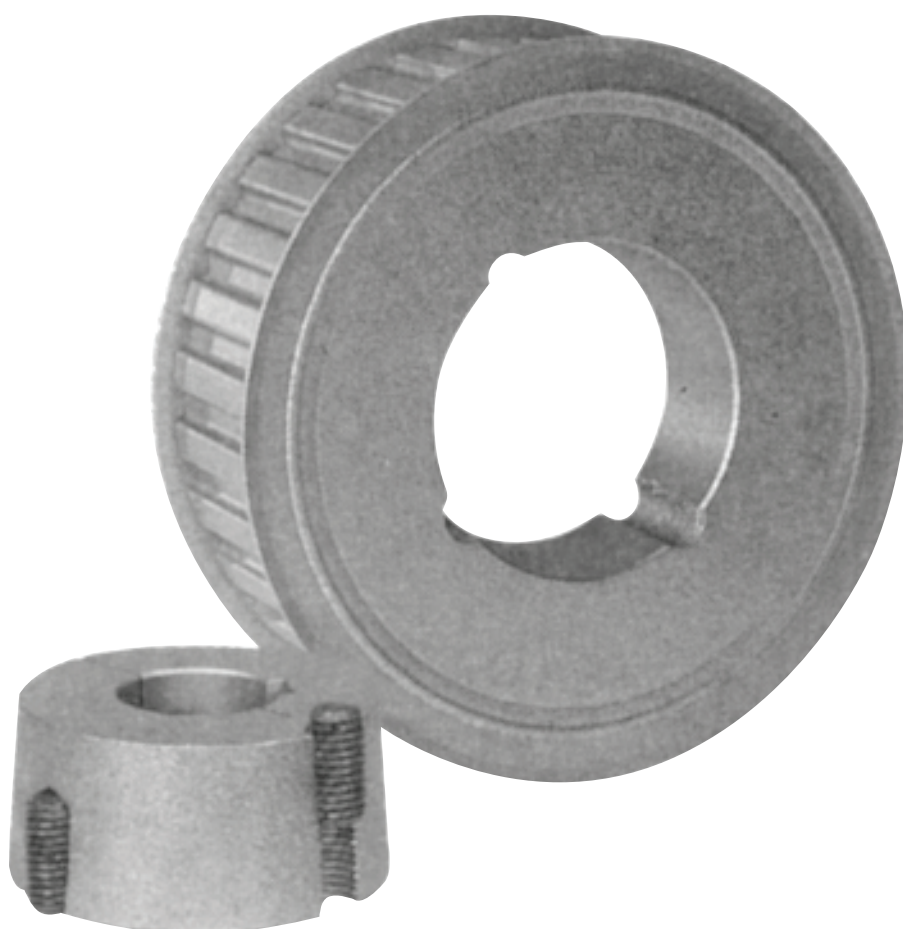

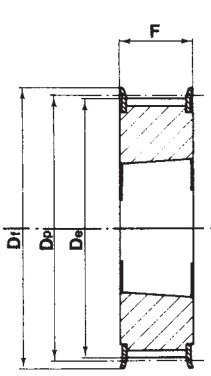

Tipo / Type
3F

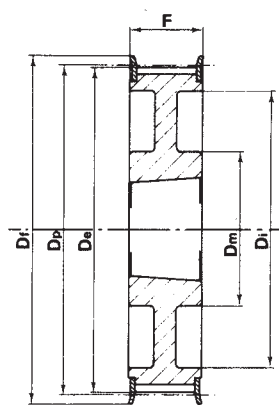

Tipo / Type
3WF

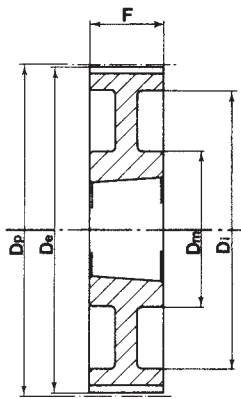

Tipo / Type
3W

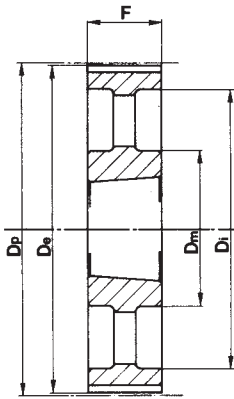

Tipo / Type
3A

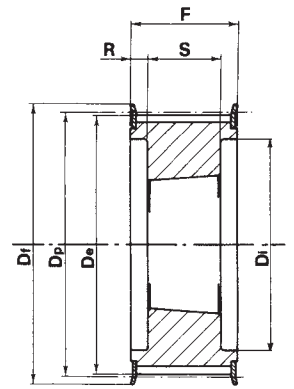

Tipo / Type
4F

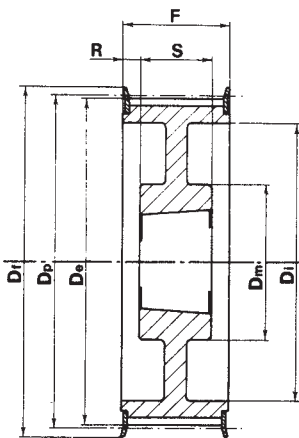

Tipo / Type
4WF

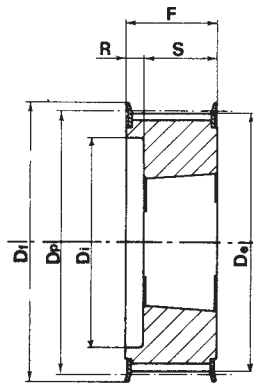

Tipo / Type
5F

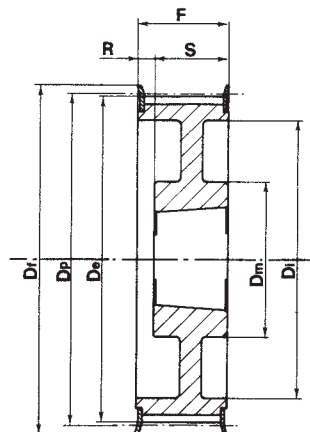

Tipo / Type
5WF

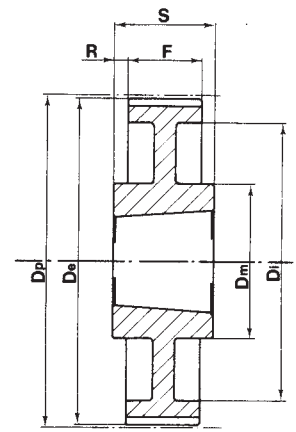

Tipo / Type
7W

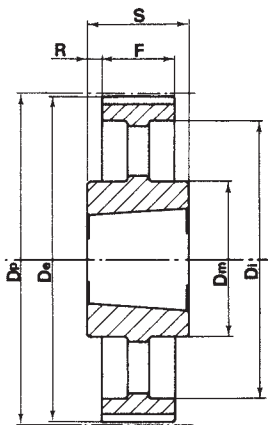

Tipo / Type
7A

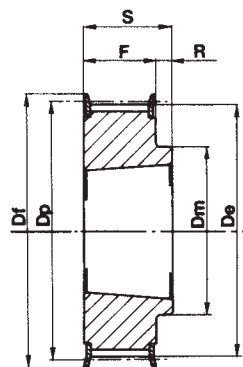

Tipo / Type
8F

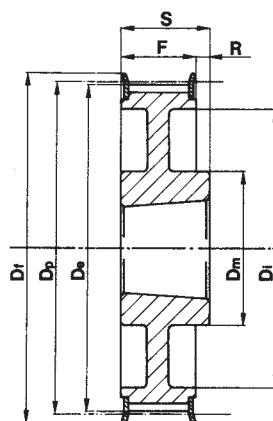

Tipo / Type
8WF

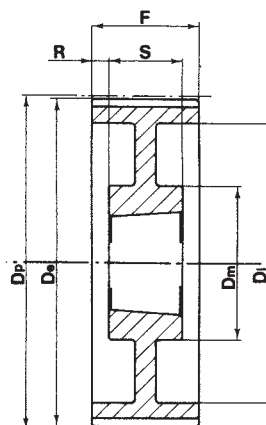

Tipo / Type
9W

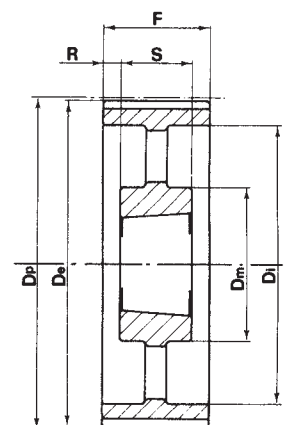

Tipo / Type
9A

Pulegge dentate per bussola conica / Timing belt pulleys for taper bushes
Zahnriemenscheiben für Spannbüchsen / Poulies dentées à moyeu amovible
Poleas dentadas para casquillos cónicos (taper)



L 050 - 3/8" (9,525 mm)

Caratteristiche Features Merkmale Características	Codice Code symbol Fabriknummer Code symbole Numero de fabrica	Nostro codice Our code Unser kode Notre code Nuestro codigo	Tipo Type Typ Type Tipo	Tipo flangia Flanges type Bordscheiben Typ Type flasques Tipo tapetas	Bussola Bush Buchse Moyeu Casquillo	Foro max. Max. Bore Max. Bohrung Alesage max. Agujero max.	Dp	De	Df	Dm	Di	F	S	R	Peso Weight / Gewicht Poids / Peso Kg	
Acciaio / Steel / Stahl Acier / Acero	con flangia / with flanges mit Flanges / avec flasques / con tapetas	18L050	TL50018	8F	F22	1108	28	54,57	53,81	60	45	-	19,0	22,0	3	0,2
		19L050	TL50019	8F	F24	1108	28	57,61	56,84	64	45	-	19,0	22,0	3	0,2
		20L050	TL50020	8F	F25	1108	28	60,64	59,88	66	48	-	19,0	22,0	3	0,2
		21L050	TL50021	8F	F26	1108	28	63,67	62,91	70	48	-	19,0	22,0	3	0,3
		22L050	TL50022	8F	F27	1108	28	66,70	65,94	75	51	-	19,0	22,0	3	0,3
		23L050	TL50023	8F	F28	1108	28	69,73	68,97	79	54	-	19,0	22,0	3	0,4
		24L050	TL50024	8F	F28	1108	28	72,77	72,00	79	54	-	19,0	22,0	3	0,4
		25L050	TL50025	8F	F29	1108	28	75,80	75,04	83	56	-	19,0	22,0	3	0,5
		26L050	TL50026	8F	F30	1108	28	78,83	78,07	87	60	-	19,0	22,0	3	0,5
		27L050	TL50027	8F	F30	1108	28	81,86	81,10	87	62	-	19,0	22,0	3	0,6
		28L050	TL50028	8F	F31	1108	28	84,89	84,13	91	65	-	19,0	22,0	3	0,6
		30L050	TL50030	8F	F33	1108	28	90,96	90,20	97	70	-	19,0	22,0	3	0,8
		32L050	TL50032	8F	F34	1108	28	97,02	96,26	102	74	-	19,0	22,0	3	0,9
		36L050	TL50036	8F	F37	1108	28	109,15	108,39	115	85	-	19,0	22,0	3	1,2
		40L050	TL50040	8F	F40	1610	42	121,28	120,51	128	88	-	19,0	25,0	3	1,5
44L050	TL50044	8WF	F45	1610	42	133,40	132,64	142	88	110	19,0	25,0	6	1,8		
48L050	TL50048	8WF	F48	1610	42	145,53	144,77	150	88	120	19,0	25,0	6	2,3		
Ghisa / Cast iron Grauguss / Fonte Hierro fundido	senza flangia / without flanges ohne Flanschen sans flasques / sin tapetas	60L050	TL50060	7W		1610	42	181,91	181,15	-	92	166	19,0	25,0	6	2,0
		72L050	TL50072	7A		1610	42	218,30	217,53	-	92	202	19,0	25,0	6	3,0
		84L050	TL50084	7A		1610	42	254,68	253,90	-	92	236	19,0	25,0	6	4,0
		96L050	TL50096	7A		2012	50	291,06	290,30	-	106	270	19,0	32,0	13	5,5
		120L050	TL50120	7A		2012	50	363,83	363,07	-	106	343	19,0	32,0	13	6,8

Pulegge dentate per bussola conica / Timing belt pulleys for taper bushes
Zahnriemenscheiben für Spannbüchsen / Poulies dentées à moyeu amovible
Poleas dentadas para casquillos cónicos (taper)

L 075 - 3/8" (9,525 mm)

Caratteristiche Features Merkmale Características	Codice Code symbol Fabriknummer Code symbole Numero de fabrica	Nostro codice Our code Unser kode Notre code Nuestro codigdo	Tipo Type Typ Type Tipo	Tipo flangia Flanges type Bordscheiben Typ Type flasques Tipo tapetas	Bussola Bush Buchse Moyeu Casquillo	Foro max. Max. Bore Max. Bohrung Alesage max. Agujero max.	Dp	De	Df	Dm	Di	F	S	R	Peso Weight / Gewicht Poids / Peso Kg	
Acciaio / Steel / Stahl Acier / Acero	con flangia / with flanges mit Flanges / avec flasques / con tapetas	18L075	TL75018	3F	F22	1108	28	54,57	53,81	60	-	25,0	25,0	-	0,2	
		19L075	TL75019	3F	F24	1108	28	57,61	56,84	64	-	25,0	25,0	-	0,3	
		20L075	TL75020	3F	F25	1108	28	60,64	59,88	66	-	25,0	25,0	-	0,3	
		21L075	TL75021	3F	F26	1108	28	63,67	62,91	70	-	25,0	25,0	-	0,4	
		22L075	TL75022	3F	F27	1108	28	66,70	65,94	75	-	25,0	25,0	-	0,4	
		23L075	TL75023	3F	F28	1108	28	69,73	68,97	79	-	25,0	25,0	-	0,4	
		24L075	TL75024	3F	F28	1108	28	72,77	72,00	79	-	25,0	25,0	-	0,5	
		25L075	TL75025	3F	F29	1108	28	75,80	75,04	83	-	25,0	25,0	-	0,6	
		26L075	TL75026	3F	F30	1108	28	78,83	78,07	87	-	25,0	25,0	-	0,6	
		27L075	TL75027	3F	F30	1108	28	81,86	81,10	87	-	25,0	25,0	-	0,7	
		28L075	TL75028	3F	F31	1108	28	84,89	84,13	91	-	25,0	25,0	-	0,7	
		30L075	TL75030	3F	F33	1108	28	90,96	90,20	97	-	25,0	25,0	-	0,9	
		32L075	TL75032	3F	F34	1108	28	97,02	96,26	102	-	25,0	25,0	-	1,0	
		36L075	TL75036	3F	F37	1610	42	109,15	108,39	115	-	25,0	25,0	-	1,2	
40L075	TL75040	3F	F40	1610	42	121,28	120,51	128	-	25,0	25,0	-	1,7			
Ghisa / Cast iron Grauguss / Fonte Hierro fundido	senza flangia without flanges ohne Flanschen sans flasques sin tapetas	44L075	TL75044	3WF	F45	1610	42	133,40	132,64	142	90	110	25,0	25,0	-	2,1
		48L075	TL75048	3WF	F48	1610	42	145,53	144,77	150	92	120	25,0	25,0	-	2,5
		60L075	TL75060	3W		1610	42	181,91	181,15	-	92	166	25,0	25,0	-	3,0
		72L075	TL75072	3A		1610	42	218,30	217,53	-	92	202	25,0	25,0	-	4,0
		84L075	TL75084	7A		2012	50	254,68	253,90	-	92	236	25,0	32,0	-	5,2
		96L075	TL75096	7A		2012	50	291,06	290,30	-	106	270	25,0	32,0	3,5	6,5
		120L075	TL75120	7A		2012	50	363,83	363,07	-	106	343	25,0	32,0	3,5	7,6

L 100 - 3/8" (9,525 mm)

Caratteristiche Features Merkmale Características	Codice Code symbol Fabriknummer Code symbole Numero de fabrica	Nostro codice Our code Unser kode Notre code Nuestro codigdo	Tipo Type Typ Type Tipo	Tipo flangia Flanges type Bordscheiben Typ Type flasques Tipo tapetas	Bussola Bush Buchse Moyeu Casquillo	Foro max. Max. Bore Max. Bohrung Alesage max. Agujero max.	Dp	De	Df	Dm	Di	F	S	R	Peso Weight / Gewicht Poids / Peso Kg	
Acciaio / Steel / Stahl Acier / Acero	con flangia / with flanges mit Flanges / avec flasques / con tapetas	18L100	TL10018	5F	F22	1108	28	54,57	53,81	60	-	38	31,0	22,0	9,0	0,2
		19L100	TL10019	5F	F24	1108	28	57,61	56,84	64	-	38	31,0	22,0	9,0	0,3
		20L100	TL10020	5F	F25	1108	28	60,64	59,88	66	-	45	31,0	22,0	9,0	0,4
		21L100	TL10021	5F	F26	1108	28	63,67	62,91	70	-	45	31,0	22,0	9,0	0,4
		22L100	TL10022	5F	F27	1108	28	66,70	65,94	75	-	48	31,0	22,0	9,0	0,4
		23L100	TL10023	5F	F28	1108	28	69,73	68,97	79	-	52	32,0	22,0	10,0	0,5
		24L100	TL10024	5F	F28	1108	28	72,77	72,00	79	-	52	32,0	22,0	10,0	0,6
		25L100	TL10025	5F	F29	1108	28	75,80	75,04	83	-	54	32,0	22,0	10,0	0,6
		26L100	TL10026	5F	F30	1108	28	78,83	78,07	87	-	60	32,0	22,0	10,0	0,7
		27L100	TL10027	5F	F30	1108	28	81,86	81,10	91	-	60	32,0	22,0	10,0	0,8
		28L100	TL10028	5F	F31	1108	28	84,89	84,13	91	-	65	32,0	22,0	10,0	0,8
		30L100	TL10030	5F	F33	1210	32	90,96	90,20	97	-	71	32,0	25,0	7,0	0,9
		32L100	TL10032	5F	F34	1210	32	97,02	96,26	102	-	75	32,0	25,0	7,0	1,0
		36L100	TL10036	5F	F37	1610	42	109,15	108,39	115	-	86	32,0	25,0	7,0	1,4
40L100	TL10040	5F	F40	1610	42	121,28	120,51	128	-	96	32,0	25,0	7,0	1,7		
Ghisa / Cast iron Grauguss / Fonte Hierro fundido	senza flangia without flanges ohne Flanschen sans flasques sin tapetas	44L100	TL10044	5WF	F45	1610	42	133,40	132,64	142	90	110	32,0	25,0	-	2,3
		48L100	TL10048	5WF	F48	1610	42	145,53	144,77	150	92	120	32,0	25,0	7,0	2,7
		60L100	TL10060	9W		1610	42	181,91	181,15	-	92	166	32,0	25,0	3,5	2,4
		72L100	TL10072	3A		2012	50	218,30	217,53	-	92	202	32,0	32,0	-	4,4
		84L100	TL10084	3A		2012	50	254,68	253,90	-	92	236	32,0	32,0	-	6,0
		96L100	TL10096	3A		2012	50	291,06	290,30	-	106	270	32,0	32,0	-	7,1
		120L100	TL10120	3A		2012	50	363,83	363,07	-	106	343	32,0	32,0	-	8,5

Pulegge dentate per bussola conica / Timing belt pulleys for taper bushes
Zahnriemenscheiben für Spannbüchsen / Poulies dentées à moyeu amovible
Poleas dentadas para casquillos cónicos (taper)



H 100 - 1/2" (12,7 mm)

Caratteristiche Features Merkmale Características Características	Codice Code symbol Fabriknummer Code symbole Numero de fabrica	Nostro codice Our code Unser kode Notre code Nuestro codiggo	Tipo Type Typ Type Tipo	Tipo flangia Flanges type Bordscheiben Typ Type flasques Tipo tapetas	Bussola Bush Buchse Moyeu Casquillo	Foro max. Max. Bore Max. Bohrung Alesage max. Agujero max.	Dp	De	Df	Dm	Di	F	S	R	Peso Weight / Gewicht Poids / Peso Kg	
Acciaio / Steel / Stahl Acier / Acero	con flangia / with flanges mit Flanges / avec flasques / con tapetas	16H100	TH10016	5F	F26	1108	28	64,68	63,31	70	-	45	31,0	22,0	9,0	0,4
		18H100	TH10018	5F	F28	1210	32	72,77	71,39	79	-	52	31,0	25,0	6,0	0,5
		19H100	TH10019	5F	F29	1210	32	76,81	75,44	83	-	56	31,0	25,0	6,0	0,6
		20H100	TH10020	5F	F30	1210	32	80,55	79,48	87	-	60	31,0	25,0	6,0	0,7
		21H100	TH10021	5F	F31	1210	32	84,89	83,52	91	-	64	32,0	25,0	7,0	0,8
		22H100	TH10022	5F	F32	1210	32	88,94	87,56	93	-	67	32,0	25,0	7,0	0,9
		23H100	TH10023	5F	F33	1610	42	92,98	91,61	97	-	70	32,0	25,0	7,0	0,9
		24H100	TH10024	5F	F34	1610	42	97,02	95,65	102	-	74	32,0	25,0	7,0	1,0
		25H100	TH10025	5F	F35	1610	42	101,06	99,69	106	-	77	32,0	25,0	7,0	1,0
		26H100	TH10026	5F	F36	1610	42	105,11	103,73	112	-	82	32,0	25,0	7,0	1,2
		27H100	TH10027	5F	F37	1610	42	109,15	107,78	115	-	85	32,0	25,0	7,0	1,3
		28H100	TH10028	5F	F38	1610	42	113,19	111,82	120	-	90	32,0	25,0	7,0	1,5
		30H100	TH10030	5F	F40	1610	42	121,28	119,90	128	-	98	32,0	25,0	7,0	1,7
		32H100	TH10032	5WF	F42	1610	42	129,36	127,99	135	80	106	32,0	25,0	7,0	2,0
		36H100	TH10036	5WF	F48	1610	42	145,53	144,16	150	92	121	32,0	25,0	7,0	2,7
		40H100	TH10040	5WF	F52	1610	42	161,70	160,33	168	92	138	32,0	25,0	7,0	3,6
44H100	TH10044	3WF	F55	2012	50	177,87	176,50	184	106	152	32,0	32,0	-	3,8		
48H100	TH10048	3WF	F59	2012	50	194,04	192,67	200	106	169	32,0	32,0	-	3,2		
Ghisa / Cast iron Grauguss / Fonte Hierro fundido	senza flangia without flanges ohne Flanschen sans flasques sin tapetas	60H100	TH10060	9A		2012	50	242,55	241,18	-	92	223	34,0	32,0	1,0	4,8
		72H100	TH10072	9A		2012	50	291,06	289,69	-	92	270	34,0	32,0	1,0	5,7
		84H100	TH10084	9A		2012	50	339,57	338,20	-	92	318	34,0	32,0	1,0	6,8
		96H100	TH10096	7A		2517	60	388,08	386,71	-	106	366	34,0	45,0	5,5	8,2
		120H100	TH10120	7A		2517	60	485,10	483,73	-	106	462	34,0	45,0	5,5	12,1

H 150 - 1/2" (12,7 mm)

Caratteristiche Features Merkmale Características Características	Codice Code symbol Fabriknummer Code symbole Numero de fabrica	Nostro codice Our code Unser kode Notre code Nuestro codiggo	Tipo Type Typ Type Tipo	Tipo flangia Flanges type Bordscheiben Typ Type flasques Tipo tapetas	Bussola Bush Buchse Moyeu Casquillo	Foro max. Max. Bore Max. Bohrung Alesage max. Agujero max.	Dp	De	Df	Dm	Di	F	S	R	Peso Weight / Gewicht Poids / Peso Kg	
Acciaio / Steel / Stahl Acier / Acero	con flangia / with flanges mit Flanges / avec flasques / con tapetas	18H150	TH15018	5F	F28	1210	32	72,77	71,39	79	-	52	45,0	25,0	20,0	0,6
		19H150	TH15019	5F	F29	1210	32	76,81	75,44	83	-	56	45,0	25,0	20,0	0,7
		20H150	TH15020	5F	F30	1210	32	80,55	79,48	87	-	60	45,0	25,0	20,0	0,8
		21H150	TH15021	5F	F31	1210	32	84,89	83,52	91	-	64	45,0	25,0	20,0	1,0
		22H150	TH15022	5F	F32	1210	32	88,94	87,56	93	-	67	45,0	25,0	20,0	1,2
		23H150	TH15023	5F	F33	1610	42	92,98	91,61	97	-	70	45,0	25,0	20,0	1,3
		24H150	TH15024	5F	F34	1610	42	97,02	95,65	102	-	74	45,0	25,0	20,0	1,0
		25H150	TH15025	5F	F35	1610	42	101,06	99,69	106	-	77	45,0	25,0	20,0	1,2
		26H150	TH15026	5F	F36	1610	42	105,11	103,73	112	-	82	45,0	25,0	20,0	1,4
		27H150	TH15027	5F	F37	1610	42	109,15	107,78	115	-	85	45,0	25,0	20,0	1,6
		28H150	TH15028	5F	F38	1610	42	113,19	111,82	120	-	90	45,0	25,0	20,0	1,8
		30H150	TH15030	5F	F40	1610	42	121,28	119,90	128	-	98	45,0	25,0	20,0	2,3
		32H150	TH15032	5WF	F42	1610	42	129,36	127,99	135	80	106	45,0	25,0	20,0	2,3
		36H150	TH15036	5WF	F48	1610	42	145,53	144,16	150	92	121	45,0	25,0	20,0	3,1
		40H150	TH15040	5WF	F52	1610	42	161,70	160,33	168	92	138	45,0	25,0	20,0	4,0
		44H150	TH15044	5WF	F55	2012	50	177,87	176,50	184	106	152	45,0	32,0	13,0	4,4
48H150	TH15048	5WF	F59	2012	50	194,04	192,67	200	106	169	45,0	32,0	13,0	4,8		
Ghisa / Cast iron Grauguss / Fonte Hierro fundido	senza flangia without flanges ohne Flanschen sans flasques sin tapetas	60H150	TH15060	9A		2012	50	242,55	241,18	-	92	223	46,0	32,0	7,5	5,4
		72H150	TH15072	9A		2012	50	291,06	289,69	-	92	270	46,0	32,0	7,5	6,5
		84H150	TH15084	9A		2012	50	339,57	338,20	-	92	318	46,0	32,0	7,5	8,4
		96H150	TH15096	9A		2517	60	388,08	386,71	-	106	366	46,0	45,0	0,5	11,0
		120H150	TH73120	9A		2517	60	485,10	483,73	-	106	462	46,0	45,0	0,5	14,8

Pulegge dentate per bussola conica / Timing belt pulleys for taper bushes
Zahnriemenscheiben für Spannbüchsen / Poulies dentées à moyeu amovible
Poleas dentadas para casquillos cónicos (taper)

H 200 - 1/2" (12,7 mm)

Caratteristiche Features Merkmal Características	Codice Code symbol Fabriknummer Code symbole Numero de fabrica	Nostro codice Our code Unser kode Notre code Nuestro codigo	Tipo Type Typ Type Tipo	Tipo flangia Flanges type Bordscheiben Typ Type flasques Tipo tapetas	Bussola Bush Buchse Moyeu Casquillo	Foro max. Max. Bore Max. Bohrung Alesage max. Agujero max.	Dp	De	Df	Dm	Di	F	S	R	Peso Weight / Gewicht Poids / Peso Kg	
Acciaio / Steel / Stahl Acier / Acero	con flangia / with flanges mit Flanges / avec flasques / con tapetas	18H200	TH20018	5F	F28	1210	32	72,77	71,39	79	-	52	58,0	25,0	33,0	0,8
		19H200	TH20019	5F	F29	1210	32	76,81	75,44	83	-	56	58,0	25,0	33,0	0,9
		20H200	TH20020	5F	F30	1610	42	80,55	79,48	87	-	60	58,0	25,0	33,0	1,0
		21H200	TH20021	5F	F31	1610	42	84,89	83,52	91	-	64	58,0	25,0	33,0	1,7
		22H200	TH20022	5F	F32	1610	42	88,94	87,56	93	-	67	58,0	25,0	33,0	1,5
		23H200	TH20023	5F	F33	1610	42	92,98	91,61	97	-	70	58,0	25,0	33,0	1,8
		24H200	TH20024	5F	F34	1610	42	97,02	95,65	102	-	74	58,0	25,0	33,0	1,5
		25H200	TH20025	5F	F35	1610	42	101,06	99,69	106	-	77	58,0	25,0	33,0	1,5
		26H200	TH20026	5F	F36	1610	42	105,11	103,73	112	-	82	58,0	25,0	33,0	1,8
		27H200	TH20027	5F	F37	1610	42	109,15	107,78	115	-	85	58,0	25,0	33,0	1,9
		28H200	TH20028	5F	F38	1610	42	113,19	111,82	120	-	90	58,0	25,0	33,0	1,9
		30H200	TH20030	5F	F40	1610	42	121,28	119,90	128	-	98	58,0	25,0	33,0	2,3
		32H200	TH20032	5F	F42	2012	50	129,36	127,99	135	-	106	58,0	32,0	26,0	3,0
		36H200	TH20036	5WF	F48	2012	50	145,53	144,16	150	102	121	58,0	32,0	26,0	3,0
		40H200	TH20040	5WF	F52	2012	50	161,70	160,33	168	106	140	58,0	32,0	26,0	3,6
		44H200	TH20044	5WF	F55	2012	50	177,87	176,50	184	106	150	58,0	32,0	26,0	4,0
48H200	TH20048	5WF	F59	2517	60	194,04	192,67	200	119	168	58,0	45,0	13,0	4,6		
Ghisa / Cast iron Grauguss / Fonte Hierro fundido	senza flangia without flanges ohne Flanschen sans flasques sin tapetas	60H200	TH20060	9A		2517	60	242,55	241,18	-	119	223	60,0	45,0	7,5	7,0
		72H200	TH20072	9A		2517	60	291,06	289,69	-	119	270	60,0	45,0	7,5	8,0
		84H200	TH20084	9A		2517	60	339,57	338,20	-	119	318	60,0	45,0	7,5	9,0
		96H200	TH20096	9A		2517	60	388,08	386,71	-	119	366	60,0	45,0	7,5	10,0
		120H200	TH20120	9A		2517	60	485,10	483,73	-	119	462	60,0	45,0	7,5	13,4

H 300 - 1/2" (12,7 mm)

Caratteristiche Features Merkmal Características	Codice Code symbol Fabriknummer Code symbole Numero de fabrica	Nostro codice Our code Unser kode Notre code Nuestro codigo	Tipo Type Typ Type Tipo	Tipo flangia Flanges type Bordscheiben Typ Type flasques Tipo tapetas	Bussola Bush Buchse Moyeu Casquillo	Foro max. Max. Bore Max. Bohrung Alesage max. Agujero max.	Dp	De	Df	Dm	Di	F	S	R	Peso Weight / Gewicht Poids / Peso Kg	
Acciaio / Steel / Stahl Acier / Acero	con flangia / with flanges mit Flanges / avec flasques / con tapetas	20H300	TH30020	4F	F31	1615	42	80,85	79,48	87	-	65	84,0	38,0	23,0	1,5
		21H300	TH30021	4F	F31	1615	42	84,89	83,52	91	-	65	84,0	38,0	23,0	1,2
		22H300	TH30022	4F	F32	1615	42	88,94	87,56	93	-	67	84,0	38,0	23,0	1,6
		23H300	TH30023	4F	F33	1615	42	92,98	91,61	97	-	70	84,0	38,0	23,0	1,8
		24H300	TH30024	4F	F34	1615	42	97,02	95,65	102	-	74	84,0	38,0	23,0	2,0
		25H300	TH30025	4F	F35	1615	42	101,06	99,69	106	-	77	84,0	38,0	23,0	2,0
		26H300	TH30026	4F	F36	1615	42	105,11	103,73	112	-	82	84,0	38,0	23,0	2,7
		27H300	TH30027	4F	F37	2012	50	109,15	107,78	115	-	85	84,0	32,0	26,0	3,0
		28H300	TH30028	4F	F38	2012	50	113,19	111,82	120	-	90	84,0	32,0	26,0	2,4
		30H300	TH30030	4F	F40	2012	50	121,28	119,90	128	-	98	84,0	32,0	26,0	2,9
		32H300	TH30032	4F	F42	2517	60	129,36	127,99	135	-	106	84,0	45,0	19,5	3,3
		36H300	TH30036	4F	F48	2517	60	145,53	144,16	150	-	121	84,0	45,0	19,5	4,5
		40H300	TH30040	4F	F52	2517	60	161,70	160,33	168	-	138	84,0	45,0	19,5	6,0
		44H300	TH30044	4WF	F55	2517	60	177,87	176,50	184	119	150	86,0	45,0	20,5	6,6
		48H300	TH30048	4WF	F59	2517	60	194,04	192,67	200	119	168	86,0	45,0	20,5	7,6
		Ghisa / Cast iron Grauguss / Fonte Hierro fundido	senza flangia without flanges ohne Flanschen sans flasques sin tapetas	60H300	TH30060	9A		2517	60	242,55	241,18	-	119	223	86,0	45,0
72H300	TH30072			9A		2517	60	291,06	289,69	-	119	270	86,0	45,0	20,5	10,4
84H300	TH30084			9A		2517	60	339,57	338,20	-	119	318	86,0	45,0	20,5	12,5
96H300	TH30096			9A		3030	75	388,08	386,71	-	150	366	86,0	76,0	5,0	14,2
120H300	TH30120			9A		3030	75	485,10	483,73	-	150	462	86,0	76,0	5,0	18,8

Pulegge dentate per bussola conica / Timing belt pulleys for taper bushes
Zahnriemenscheiben für Spannbüchsen / Poulies dentées à moyeu amovible
Poleas dentadas para casquillos cónicos (taper)



XH 200 - 7/8" (22,225 mm)

Caratteristiche Features Merkmale Características Características	Codice Code symbol Fabriknummer Code symbole Numero de fabrica	Nostro codice Our code Unser kode Notre code Nuestro codigo	Tipo Type Typ Type Tipo	Tipo flangia Flanges type Bordscheiben Typ Type flasques Tipo tapetas	Bussola Bush Buchse Moyeu Casquillo	Foro max. Max. Bore Max. Bohrung Alesage max. Agujero max.	Dp	De	Df	Dm	Di	F	S	R	Peso Weight / Gewicht Poids / Peso Kg
Ghisa / Cast iron Grauguss / Fonte Hierro fundido	con flangia / with flanges mit Flanges / avec flasques / con tapetas	18XH200	TXH2018	5F	F44	2517	60	127,34	124,55	140	-	95	64	45	19,0
		20XH200	TXH2020	5F	F49	2517	60	141,49	138,69	154	-	110	64	45	19,0
		22XH200	TXH2022	5F	F52	2517	60	155,64	152,84	168	-	120	64	45	19,0
		24XH200	TXH2024	5F	F55	2517	60	169,79	166,99	184	-	135	64	45	19,0
		26XH200	TXH2026	5F	F59	2517	60	183,94	181,14	200	-	150	64	45	19,0
		28XH200	TXH2028	4WF	F61	2517	60	198,08	195,29	212	120	165	64	45	9,5
		30XH200	TXH2030	4WF	F62	2517	60	212,23	209,44	226	120	180	64	45	9,5
		32XH200	TXH2032	4WF	F64	2517	60	226,38	223,59	240	120	195	64	45	9,5
		40XH200	TXH2040	4WF	F70	3020	75	282,98	280,18	296	160	245	64	51	9,5
	senza flangia / without flanges ohne Flanschen / sans flasques sin tapetas	48XH200	TXH2048	9W		3020	75	339,57	336,78	-	160	300	64	51	6,5
		60XH200	TXH2060	7A		3535	90	424,47	421,67	-	190	385	64	89	12,5
		72XH200	TXH2072	7A		3535	90	509,40	506,56	-	190	470	64	89	12,5
		84XH200	TXH2084	7A		3535	90	594,25	591,46	-	190	555	64	89	12,5
		96XH200	TXH2096	7A		3535	90	679,15	676,35	-	190	640	64	89	12,5
		120XH200	TXH2120	7A		3535	90	848,93	846,14	-	190	810	64	89	12,5

XH 300 - 7/8" (22,225 mm)

Caratteristiche Features Merkmale Características Características	Codice Code symbol Fabriknummer Code symbole Numero de fabrica	Nostro codice Our code Unser kode Notre code Nuestro codigo	Tipo Type Typ Type Tipo	Tipo flangia Flanges type Bordscheiben Typ Type flasques Tipo tapetas	Bussola Bush Buchse Moyeu Casquillo	Foro max. Max. Bore Max. Bohrung Alesage max. Agujero max.	Dp	De	Df	Dm	Di	F	S	R	Peso Weight / Gewicht Poids / Peso Kg
Ghisa / Cast iron Grauguss / Fonte Hierro fundido	con flangia / with flanges mit Flanges / avec flasques / con tapetas	18XH300	TXH3018	5F	F44	2517	60	127,34	124,55	140	-	95	90	45	45,0
		20XH300	TXH3020	5F	F49	2517	60	141,49	138,69	154	-	110	90	45	45,0
		22XH300	TXH3022	5F	F52	2517	60	155,64	152,84	168	-	120	90	45	45,0
		24XH300	TXH3024	5F	F55	2517	60	169,79	166,99	184	-	135	90	45	45,0
		26XH300	TXH3026	5F	F59	2517	60	183,94	181,14	200	-	150	90	45	45,0
		28XH300	TXH3028	5F	F61	3020	75	198,08	195,29	212	120	165	90	51	39,0
		30XH300	TXH3030	5F	F62	3020	75	212,23	209,44	226	120	180	90	51	39,0
		32XH300	TXH3032	5F	F64	3020	75	226,38	223,59	240	120	195	90	51	39,0
		40XH300	TXH3040	4WF	F70	3020	75	282,98	280,18	296	160	245	90	51	19,5
	senza flangia / without flanges ohne Flanschen / sans flasques sin tapetas	48XH300	TXH3048	9A		3020	75	339,57	336,78	-	160	300	90	51	19,5
		60XH300	TXH3060	9A		3535	90	424,47	421,67	-	190	385	90	89	0,5
		72XH300	TXH3072	9A		3535	90	509,40	506,56	-	190	470	90	89	0,5
		84XH300	TXH3084	7A		4040	100	594,25	591,46	-	190	555	90	102	6,0
		96XH300	TXH3096	7A		4040	100	679,15	676,35	-	190	640	90	102	6,0
		120XH300	TXH3120	7A		4040	100	848,93	846,14	-	190	810	90	102	6,0

XH 400 - 7/8" (22,225 mm)

Caratteristiche Features Merkmale Características	Codice Code symbol Fabriknummer Code symbole Numero de fabrica	Nostro codice Our code Unser kode Notre code Nuestro codigo	Tipo Type Typ Type Tipo	Tipo flangia Flanges type Bordscheiben Typ Type flasques Tipo tapetas	Bussola Bush Buchse Moyeu Casquillo	Foro max. Max. Bore Max. Bohrung Alesage max. Agujero max.	Dp	De	Df	Dm	Di	F	S	R	Peso Weight / Gewicht Poids / Peso Kg
Ghisa / Cast iron Grauguss / Fonte Hierro fundido	con flangia / with flanges mit Flanges / avec flasques / con tapetas	18XH400	TXH4018	5F	F44	2517	60	127,34	124,55	140	-	95	119	45	74,0
		20XH400	TXH4020	5F	F49	2517	60	141,49	138,69	154	-	110	119	45	74,0
		22XH400	TXH4022	5F	F52	2517	60	155,64	152,84	168	-	120	119	45	74,0
		24XH400	TXH4024	5F	F55	3020	75	169,79	166,99	184	-	135	119	51	68,0
		26XH400	TXH4026	5F	F59	3020	75	183,94	181,14	200	-	150	119	51	68,0
		28XH400	TXH4028	5F	F61	3020	75	198,08	195,29	212	120	165	119	51	68,0
		30XH400	TXH4030	5F	F62	3020	75	212,23	209,44	226	120	180	119	51	68,0
		32XH400	TXH4032	5F	F64	3020	75	226,38	223,59	240	120	195	119	51	68,0
		40XH400	TXH4040	4WF	F70	3535	90	282,98	280,18	296	160	245	119	89	15,0
	senza flangia / without flanges ohne Flanschen / sans flasques sin tapetas	48XH400	TXH4048	9W		3535	90	339,57	336,78	-	160	300	119	89	15,0
		60XH400	TXH4060	9A		4040	100	424,47	421,67	-	190	385	119	102	8,5
		72XH400	TXH4072	9A		4040	100	509,40	506,56	-	190	470	119	102	8,5
		84XH400	TXH4084	9A		4040	100	594,25	591,46	-	190	555	119	102	8,5
		96XH400	TXH4096	9A		4040	100	679,15	676,35	-	190	640	119	102	8,5
		120XH400	TXH4120	9A		4040	100	848,93	846,14	-	190	810	119	102	8,5